

DICTIONNAIRE

TECHNOLOGIQUE

OU

NOUVEAU DICTIONNAIRE UNIVERSEL

DES ARTS ET MÉTIERS

ET DE L'ÉCONOMIE INDUSTRIELLE ET COMMERCIALE ;

PAR

UNE SOCIÉTÉ DE SAVANS ET D'ARTISTES.

ATLAS.



TOME PREMIER

CONTENANT {
1°. LES PLANCHES DES ARTS DE CALCUL ;
2°. LES PLANCHES DES ARTS CHIMIQUES ;
3°. LES PLANCHES DES ARTS PHYSIQUES.

A PARIS,

CHEZ THOMINE, LIBRAIRE, RUE DE LA HARPE, 88.

1835

Bains de Vapeurs

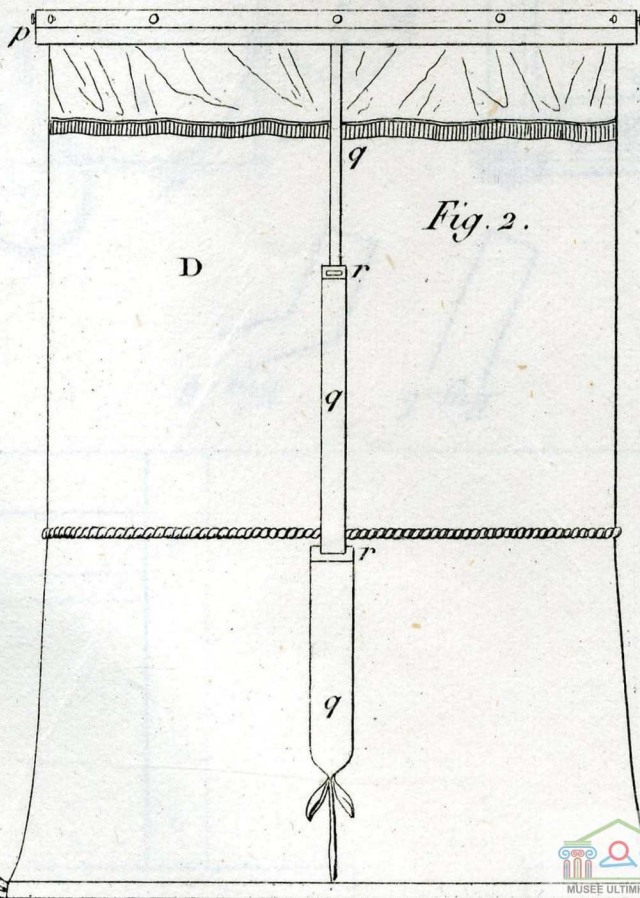
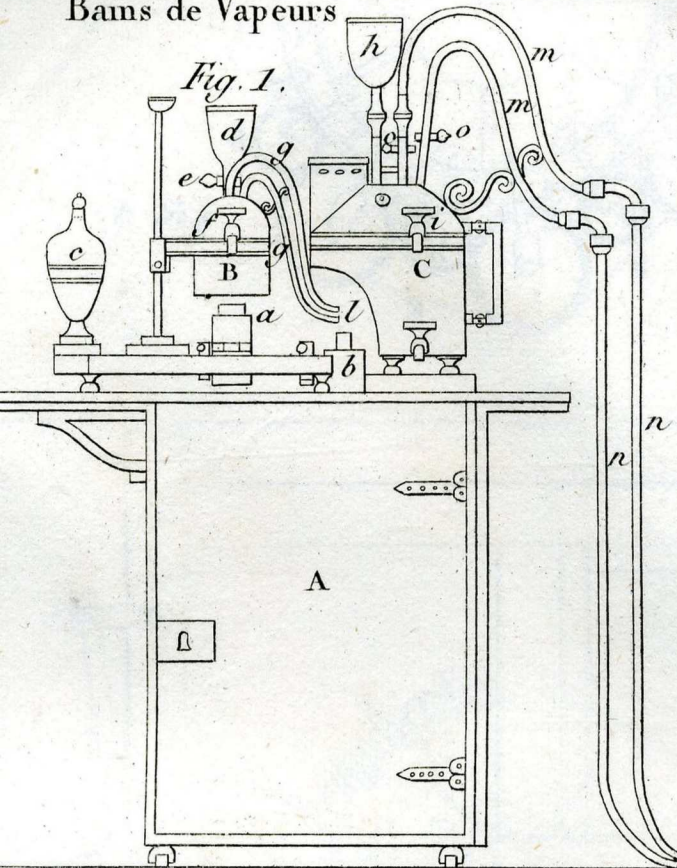

Caléfacteur et Cuisine .

Fig. 3.

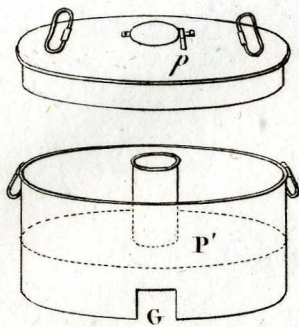
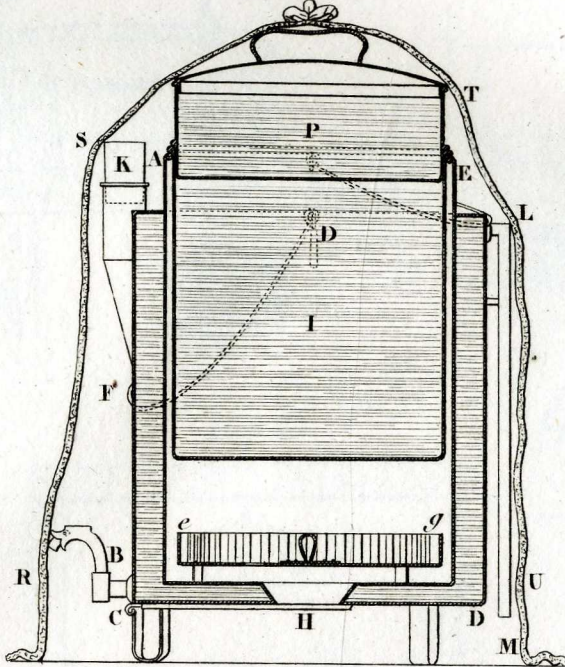

Fig. 1.

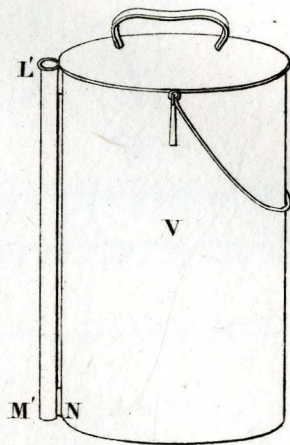
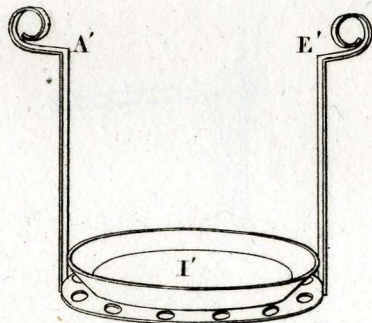

Fig. 2

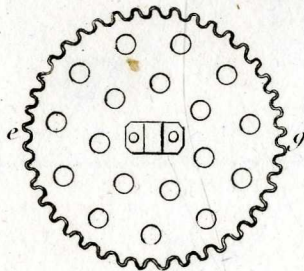

Fig. 1.

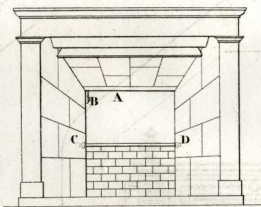
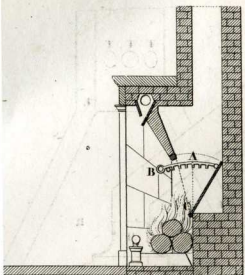

Fig. 2.

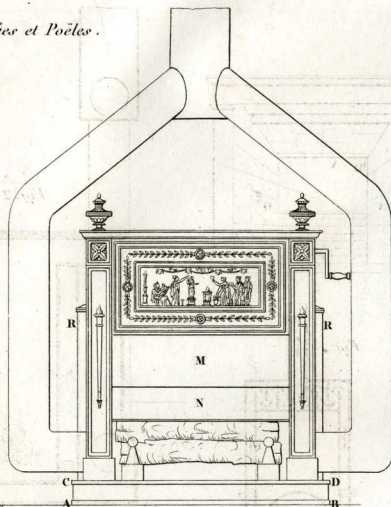
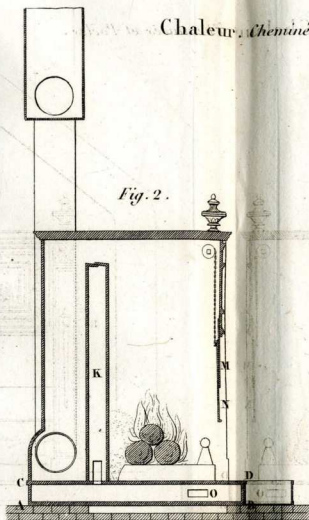

Fig. 3.

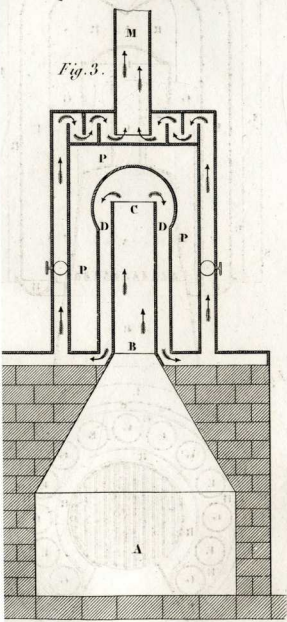

Fig. 4.

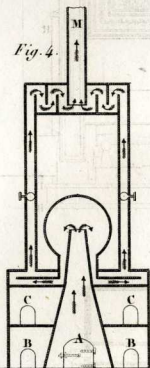

Fig. 6.

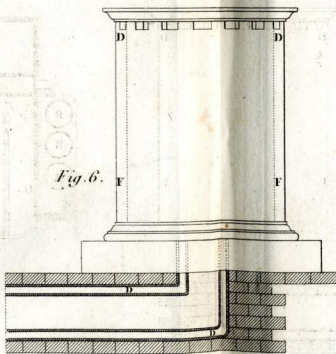

Fig. 2.

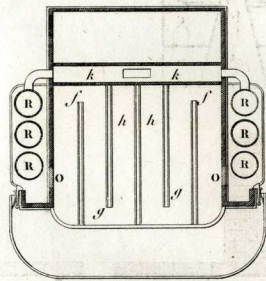
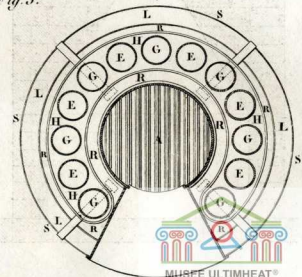

Fig. 5.



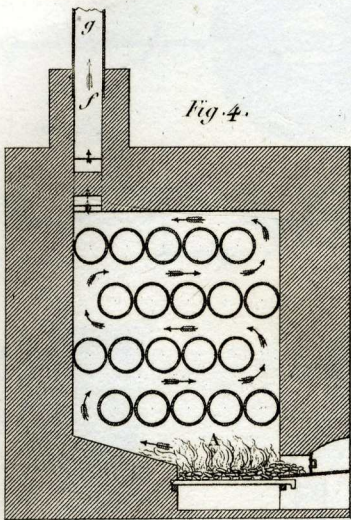
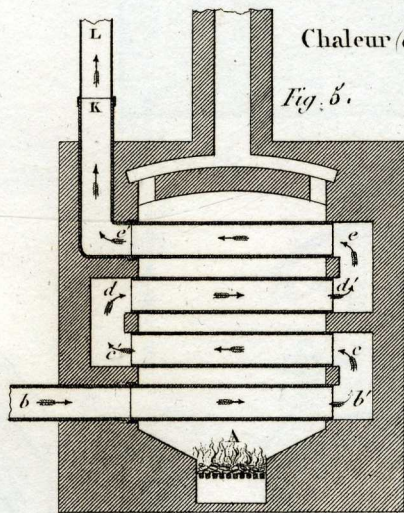

Fig. 4.



Chaleur (Calorifères.)

Fig. 5.

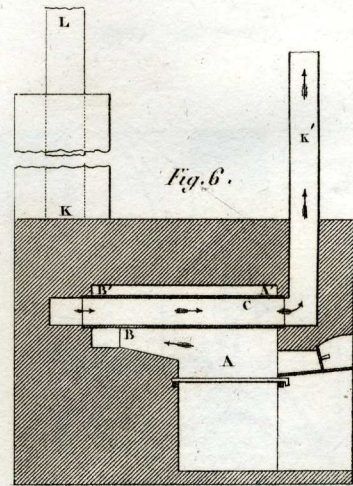
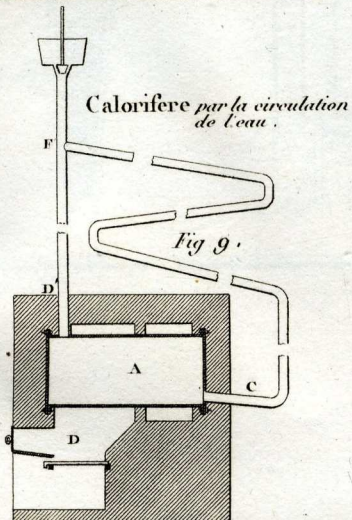

Fig. 6.



Calorifère par la circulation de l'eau.

Fig. 9.

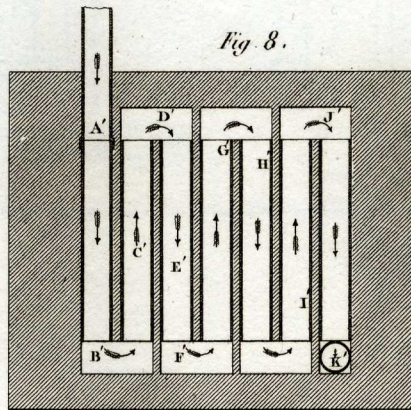

Fig. 8.

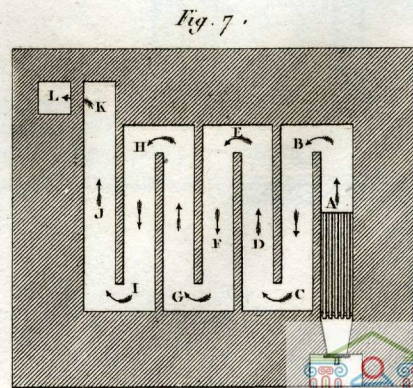

Fig. 7.

Fourneaux de Laboratoire.

Fig. 2.

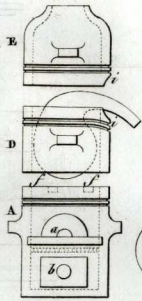

Fig. 3.

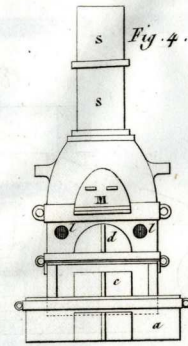
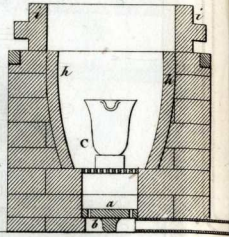

Fig. 5.

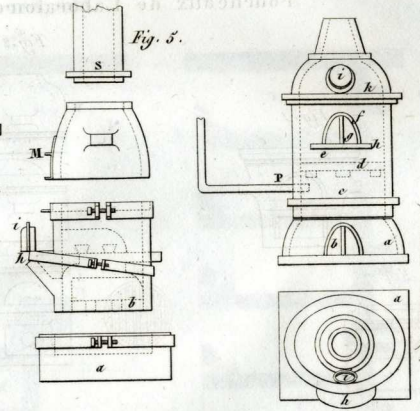

Fig. 7.

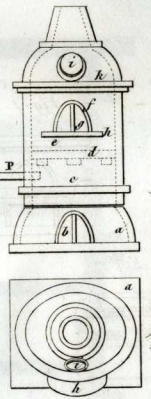

Fig. 1.

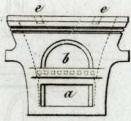
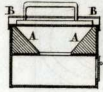

Fig. 17.



Fourneaux de Cuisine.

Fig. 11.

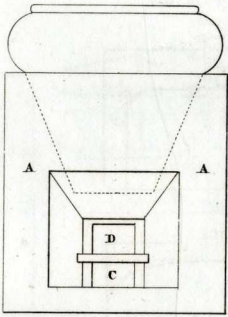

Fig. 13 (bis)

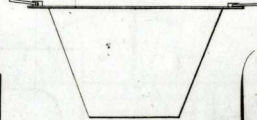

Fig. 15

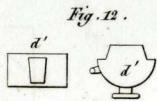

Fig. 12.

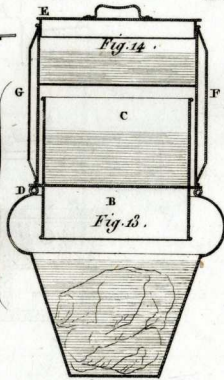

Fig. 13.

Fig. 19.

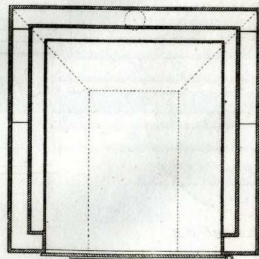

Fig. 10.

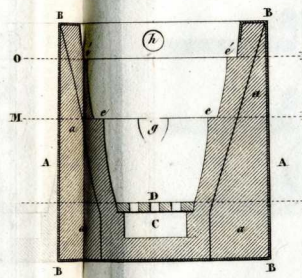

Fig. 6.



Fig. 8.

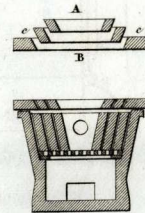

Fig. 16 (bis)

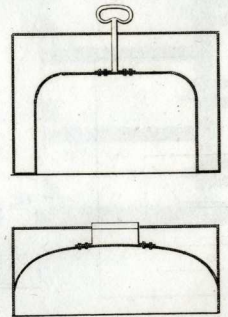
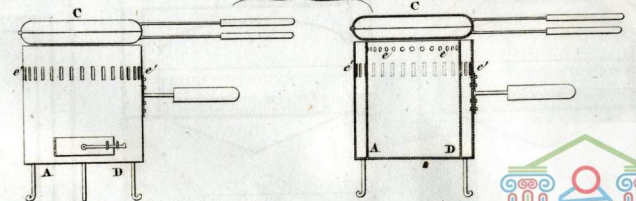

Fig. 16.



Coupe suivant O.P.

Incubation artificielle et régulateur du feu.

Fig. 1.

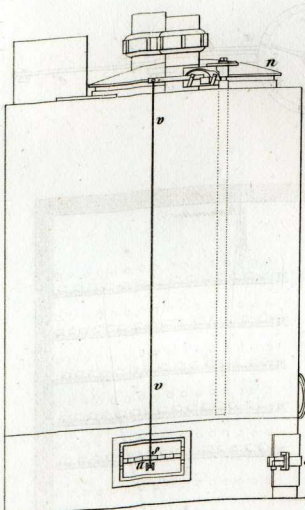

Fig. 3.

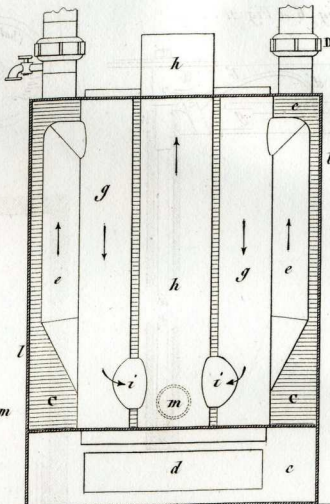

Fig. 5.

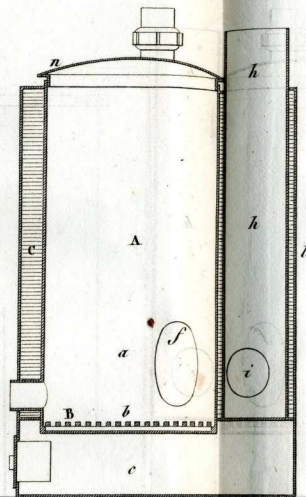

Fig. 6 et Fig. 11.

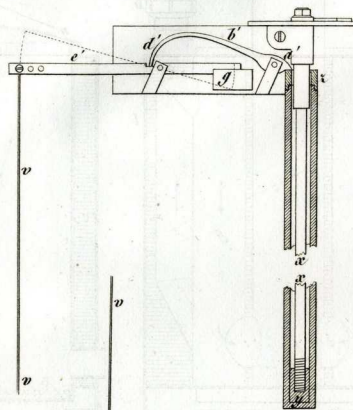

Fig. 7.

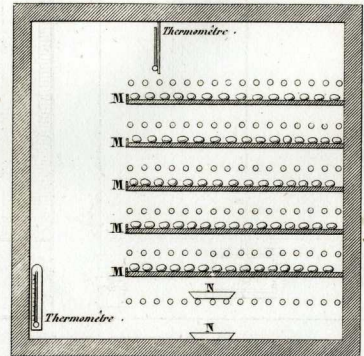
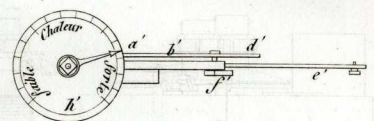

Fig. 2.

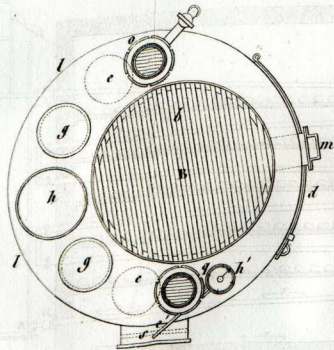

Fig. 4.

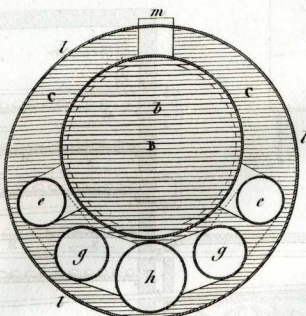

Fig. 8.

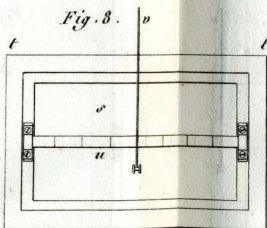

Fig. 9.

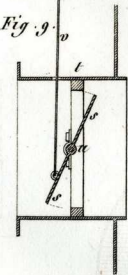
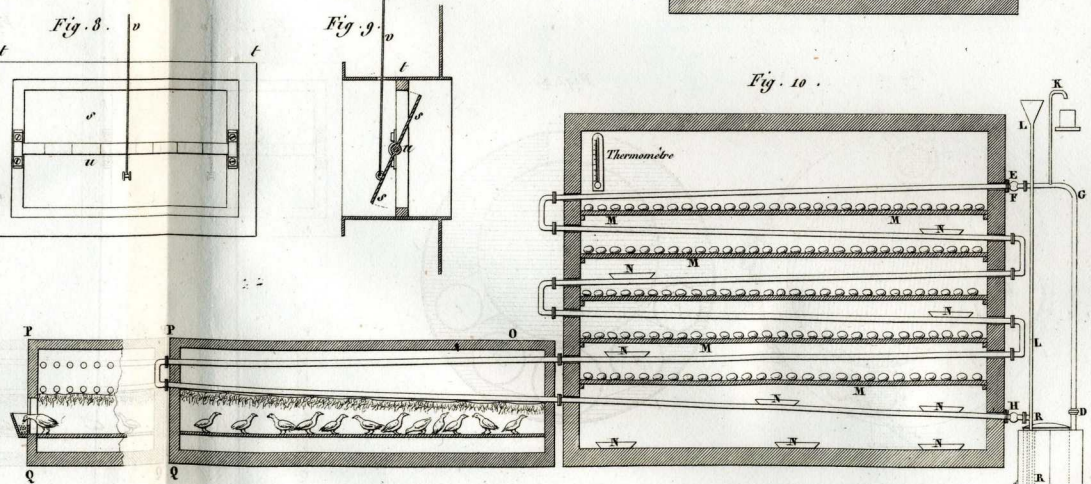

Fig. 10.



Revisé et gravé par Olivier.

Baromètres

Fig. 8.

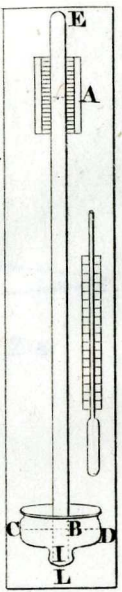

Fig. 9.

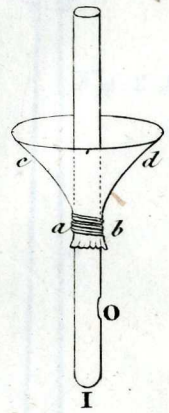

Fig. 13.

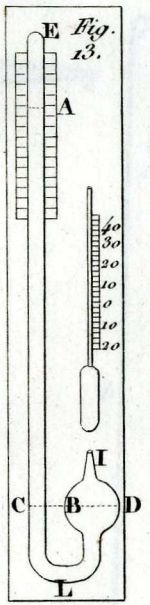

Fig. 14.

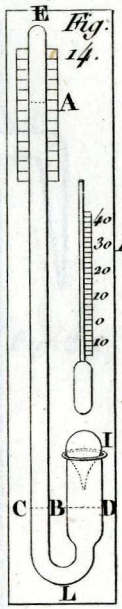

Fig. 17.

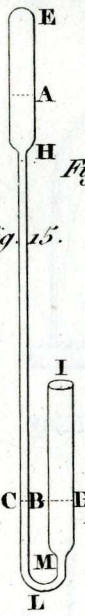

Fig. 15.

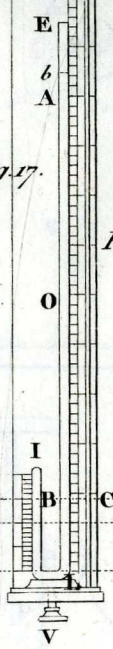

Fig. 10.

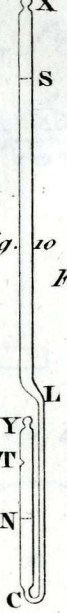

Fig. 11.

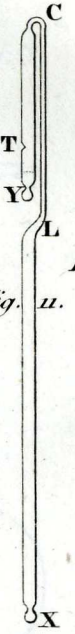

Fig. 18.

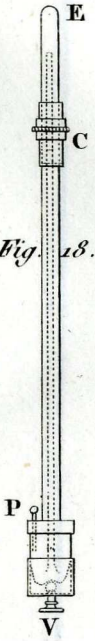

Fig. 19.

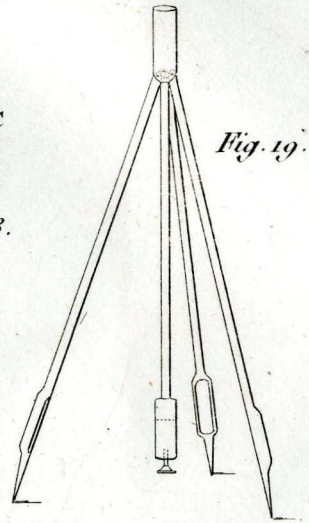
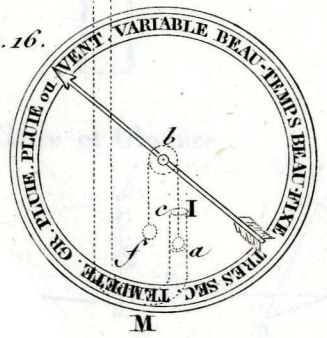

Fig. 16.



Hygromètre

Fig. 4.



Fig. 4, bis.

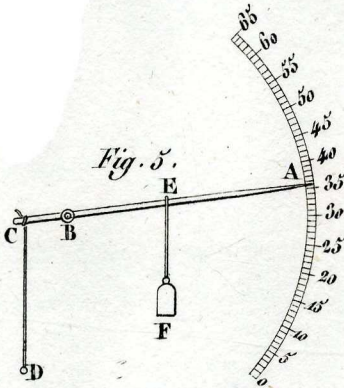
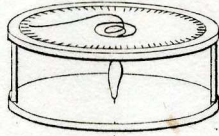

Fig. 5.

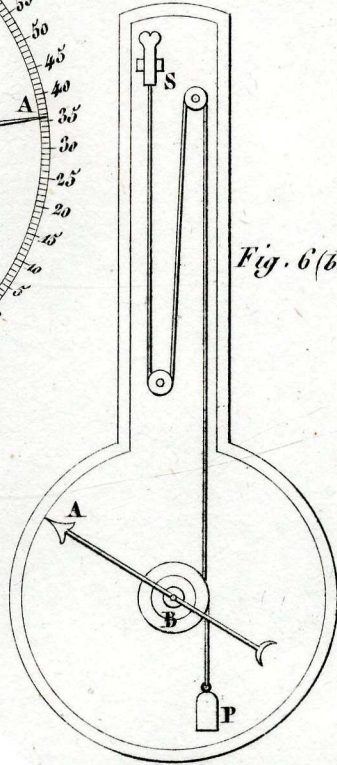

Fig. 6 (bis)

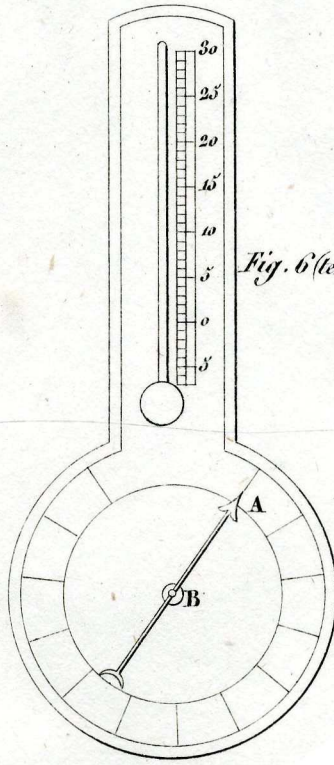

Fig. 6 (ter)



Fig. 6.

Hygromètre
de Saussure.

Fig. 10.

Manomètre

